

TWO AXIS MAGNETOMETER COMPONENT WITH FLOATING CORE

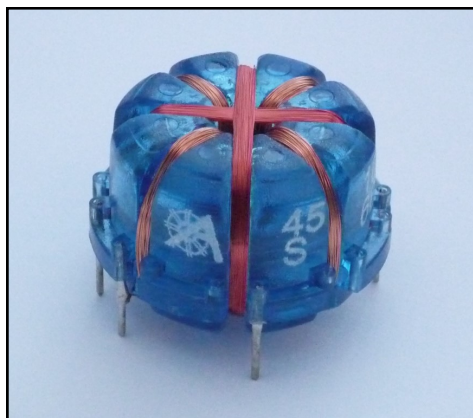

FEATURES

- Fluxgate Technology
- Self-gimballed core keeps output constant with Tilt
- Available with and without Viscous Damping

APPLICATIONS

- Marine Compass
- Vehicle Compass



ABSOLUTE MAXIMUM RATINGS

PARAMETER	DESCRIPTION	NOTES	CONDITIONS	VALUE	UNIT
T _{STOR}	Storage Temp Range			-60 to +100	°C
T _{OPER}	Operating Temp Range			-40 to +90	°C
	Shock Resistance		Single impact	±40	g
	Vibration Resistance		60Hz, 10Min	±11	g
	Climate Test		+71°C at 95% Humidity -20°C at 85% Humidity	6	Hours
I _{E(MAX)}	Max Current in Excitation Winding			200	mA
I _{S(MAX)}	Max Current in Sense Winding			80	mA
P _{MAX}	Operating Pressure Range			-0.5 to +1	Bar
ALT _{MAX}	Operating Altitude Range			-2000 to +6000	Metres

SPECIFICATIONS

		min	typ	max	Unit
ERR _{OFFSET}	Offset Error at magnetic 0 unit to unit			3	±Deg
ERR _{LIN}	Linearity Error over 360deg			3	±Deg
NTE ₄	Northerly Turning tilt range for 4 degrees of error			45	±Deg
NTE ₂	Northerly Turning tilt range for 1.5 degrees of error	40		45	±Deg
NTE ₁	Northerly Turning tilt range for 1 degree of error	35		45	±Deg

ORDER INFORMATION

PART	DESCRIPTION
AR45S	45deg fluxgate

AR45D	45deg fluxgate damped
AR45SU	45deg fluxgate ultradamped

MECHANICAL RESPONSE

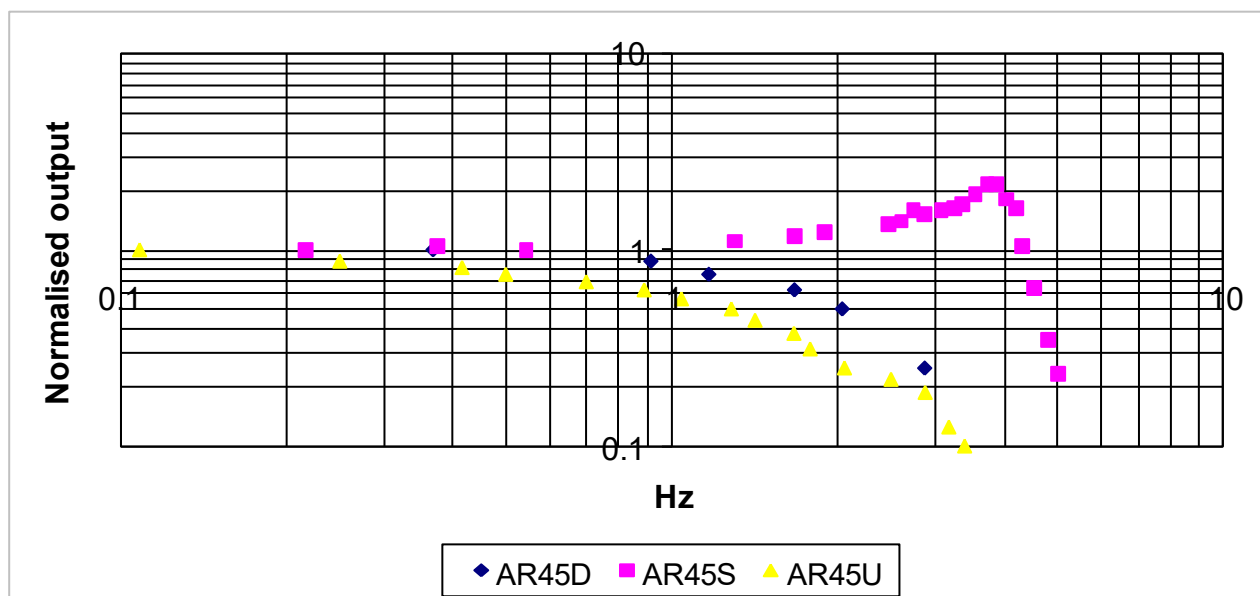

ELECTRICAL CHARACTERISTICS AT 20°C

AR45 - EXCITATION WINDING							
PARAMETER	DESCRIPTION	NOTES	CONDITIONS	MIN	TYP	MAX	UNIT
$I_{E(SAT)}$	Saturation Current	1			25	35	mA
R_E	DC Resistance				17.8		Ohms
L_E	Inductance	3	$I_E = 1 \text{ mA}$		5.2		mH
			$I_E = 10 \text{ mA}$		0.95		
			$I_E = 100 \text{ mA}$		0.50		
AR45 - SENSE WINDINGS							
PARAMETER	DESCRIPTION	NOTES	CONDITIONS	MIN	TYP	MAX	UNIT
R_S	DC Resistance				60.0		Ohms
L_S	Inductance	4	$I_E = 1 \text{ mA}$		1.62		mH
			$I_E = 10 \text{ mA}$		1.52		
			$I_E = 100 \text{ mA}$		1.33		
V_S	Typical Output	2	Core Fully Saturated, 1 kW load.		3.4		V/mT

NOTES

1. $I_{E(SAT)}$ is defined as the current required to reduce effective permeability of core to the point where winding inductance measures within 2% of that of an equivalent sized air-cored coil.
 2. Measured in UK, horizontal component of Earth's magnetic field = 60mT

3. Measured using a Wavetek 27XT inductance meter. Fluxgate under test was wound with two identical excitation windings. First winding was connected to DC current source, and inductance was measured on second winding.
 4. Measured using a Wavetek 27XT inductance meter

MECHANICAL DATA

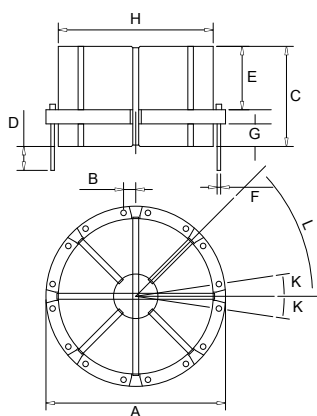

SYMBOL	DIMENSION (Note 1)	
	AR45xx	TOLERANCE
A	32.4	±0.15
B	2.2	±0.05
C	21.0	±0.1
D	2.6	±0.1
E	12.8	±0.1
F	0.635	±0.05
G	5.5	±0.1
H	28.0	±0.15
J	15.0	±0.1
K	8.33°	±0.5°
L	45.0°	±0.25°
M	0.80	-0 +0.2
N	2.54	-0.5+0.1

NOTE:
1. All dimensions in millimeters unless otherwise specified.

SCHEMATIC SYMBOL

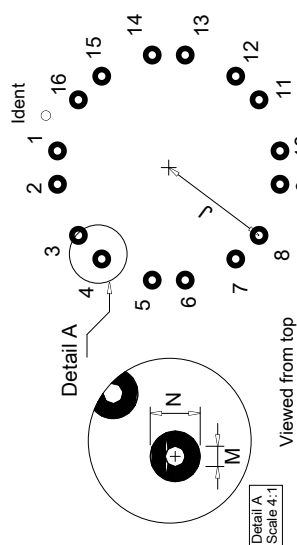
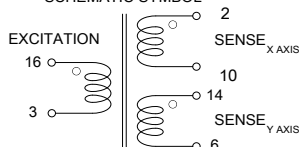

PCB PIN LOCATION		
PIN No.	X	Y
1	-2.2	14.8
2	2.2	14.8
3	9.0	12.0
4	12.0	9.0
5	14.8	2.2
6	14.8	-2.2
7	12.0	-9.0
8	9.0	-12.0
9	2.2	-14.8
10	-2.2	-14.8
11	-9.0	-12.0
12	-12.0	-9.0
13	-14.8	-2.2
14	-14.8	2.2
15	-12.0	9.0
16	-9.0	12.0

ELECTRICAL CHARACTERISTICS AT 20°C

Excitation

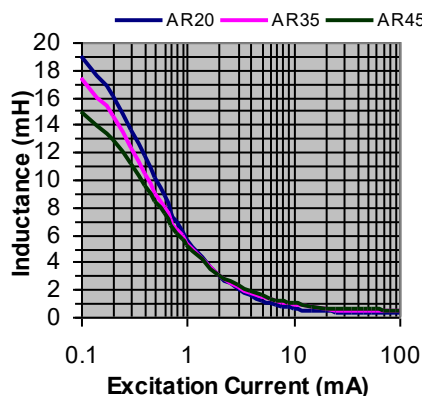

Sense

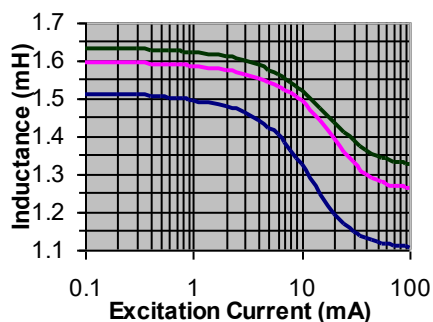

Typical Output
Vertical 100mV/div
Horizontal 20ms/div

NOTES

- For suitable circuit design see Autonnac Application notes
- The component may be mounted upside down
- This component is suitable for hand soldering only and may not be reflowed
- Recommended flux cleaning is with white spirit and brush
- If the component is to be spaced from the board a spacer (part number A1026) should be used
- No other component should be in contact with the AR45 either at rest or under shock
- The component should be handled with care

WARNING

Always check the suitability of the products for any particular purpose in a trial. Not suitable for life-support. Information is based on the current state of our knowledge. We will change our information from time to time. We reserve the right to make changes and improvements at any time.

FLUXGATE WORLD®